

1

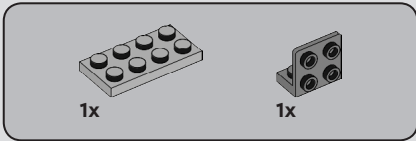

2

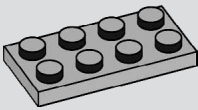
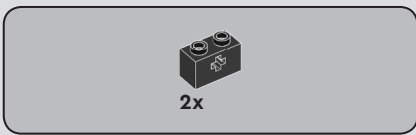
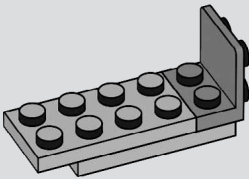

3

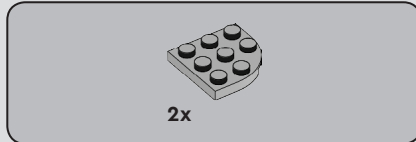
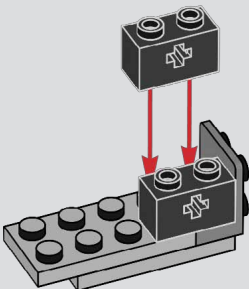

4

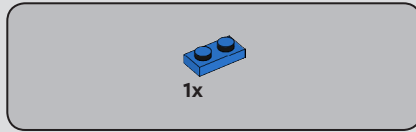
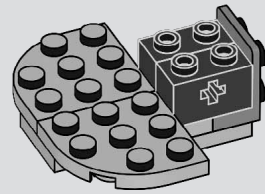

5

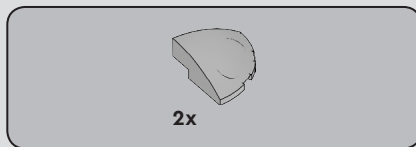
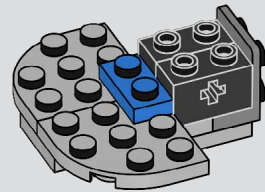

6

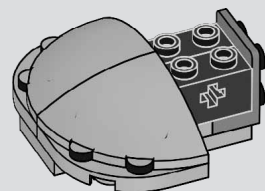

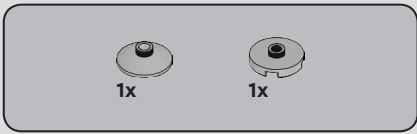

7

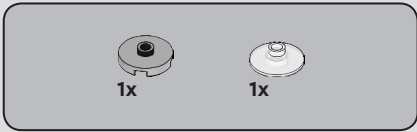
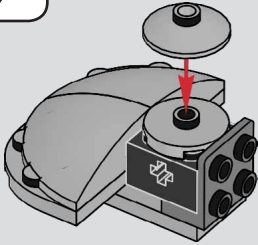

8

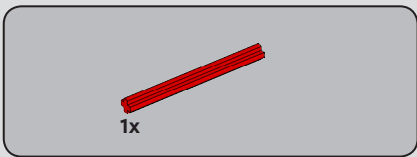
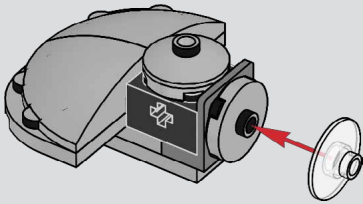

9

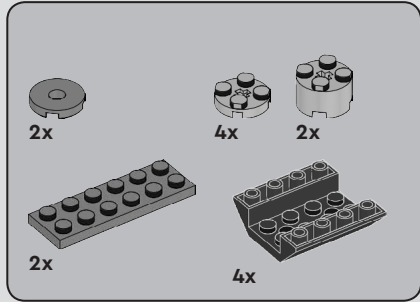
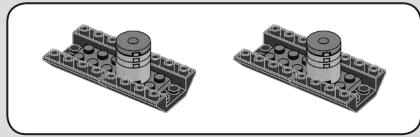
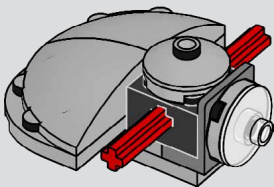

10

1

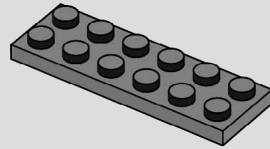

2

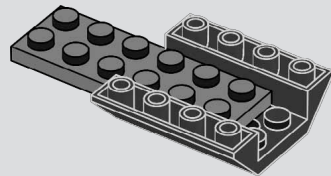

3

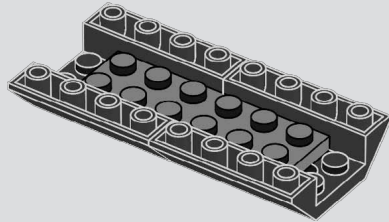

4

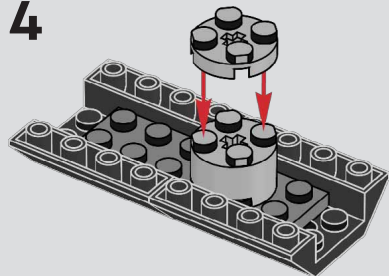

5

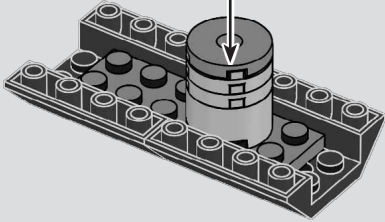
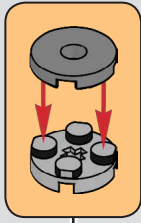

2x

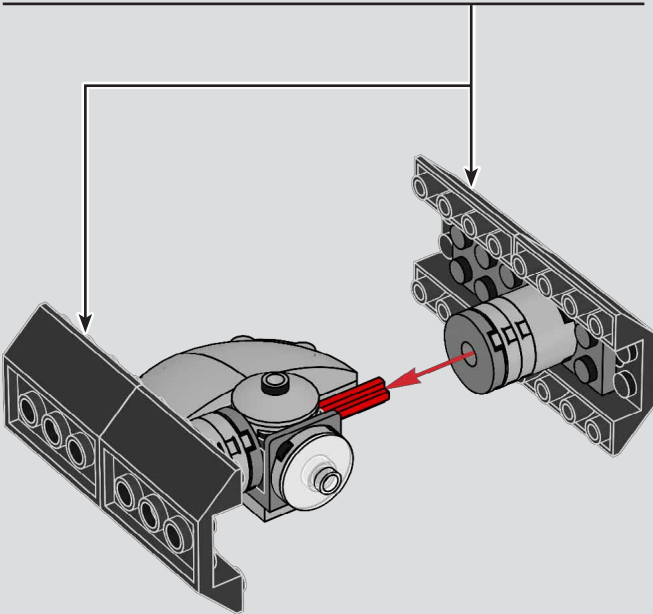

4x
4658977



2x
6407412



1x
4211512

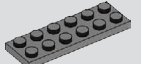

2x
4211002



2x
6178922

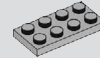

2x
4211395



2x
4645412



1x
6308045



1x
6245306



4x
4211475



1x
6130002



2x
6055313



2x
4211526



2x
6183782



1x
302323