

1

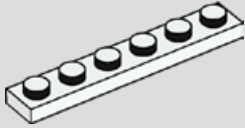

2

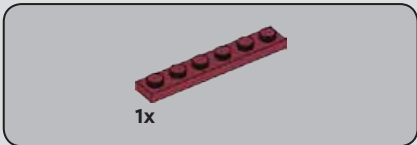
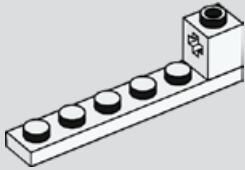

3

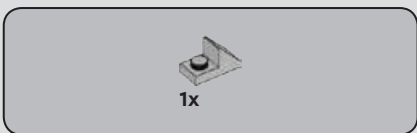
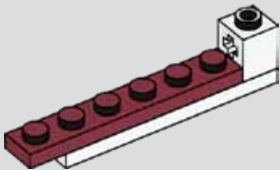

4

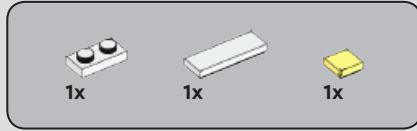
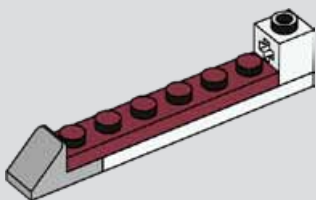

5

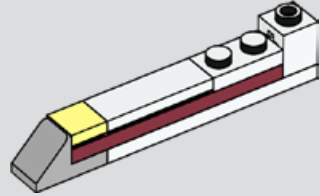

6

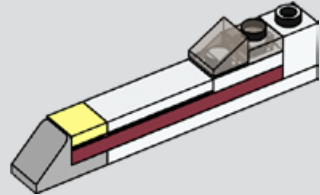

7

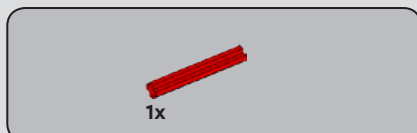
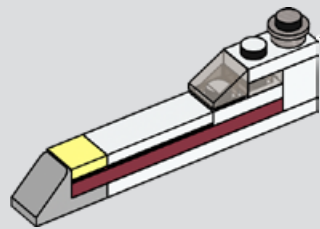
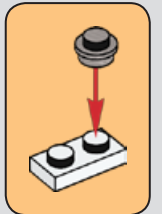

8

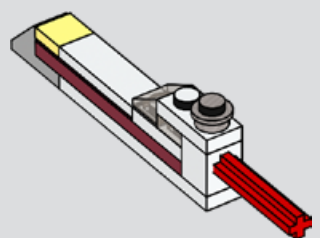

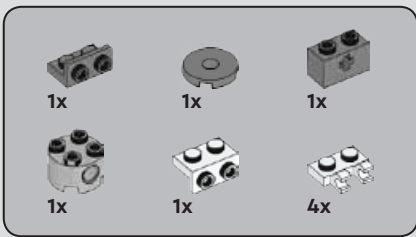

9

1



2

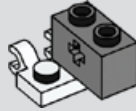

3

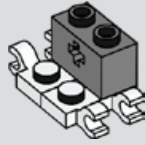

4

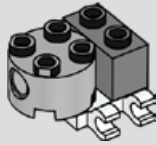

5

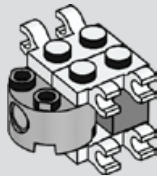

6

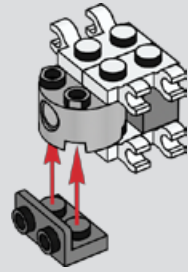

7

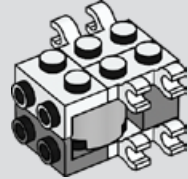

8

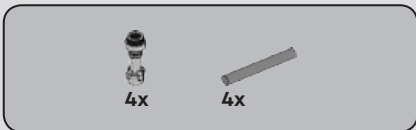
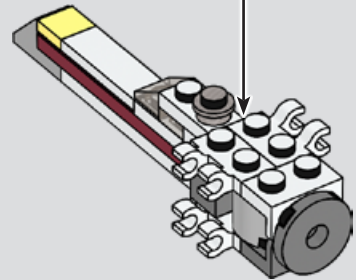
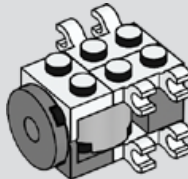

10

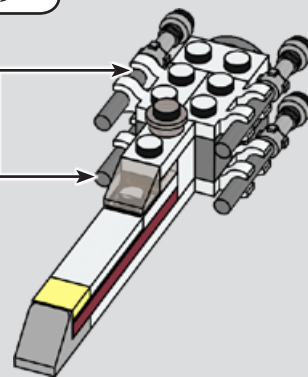
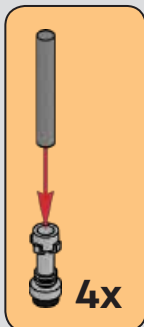

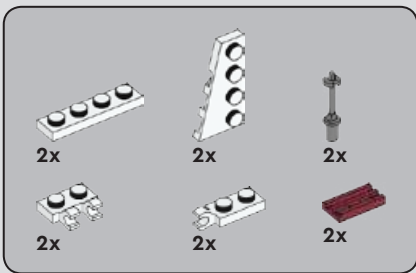

11

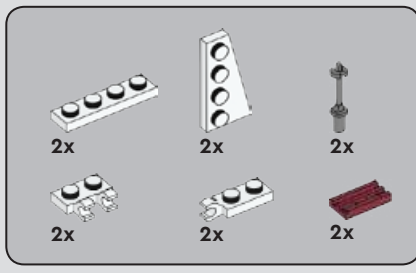
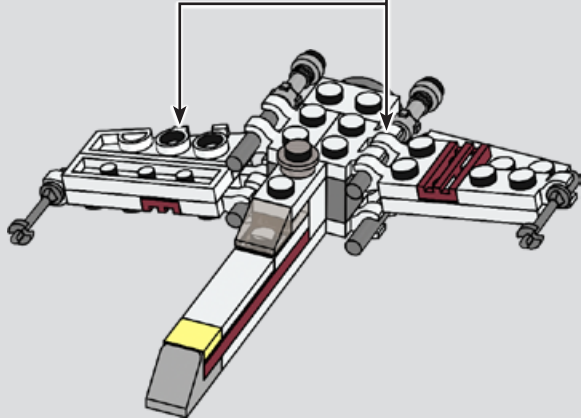
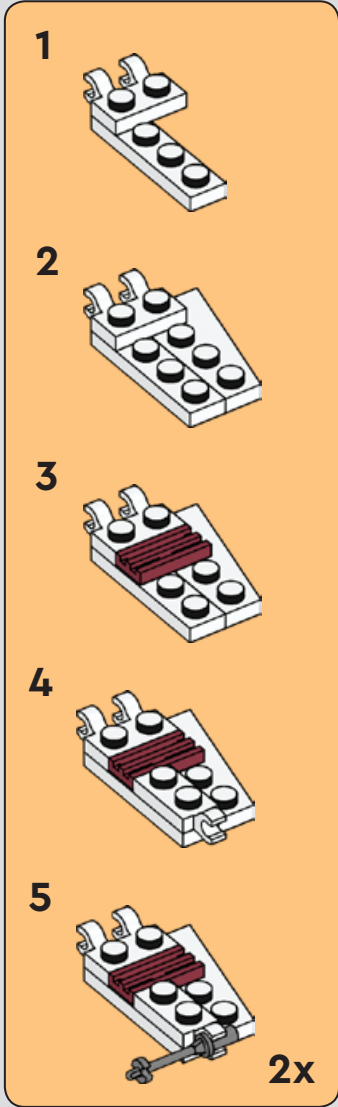

12

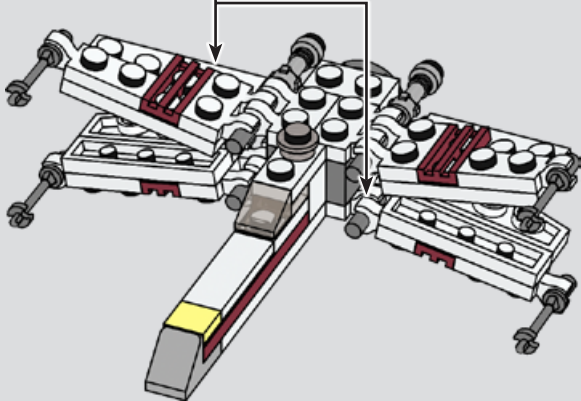
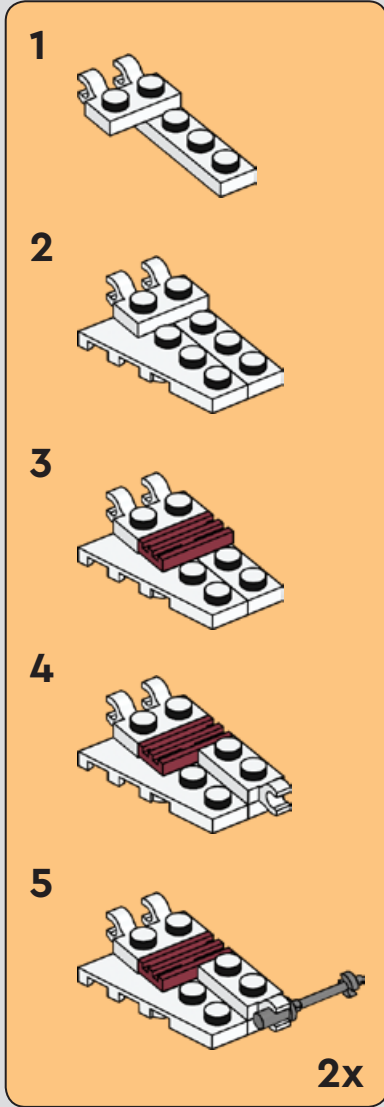



13

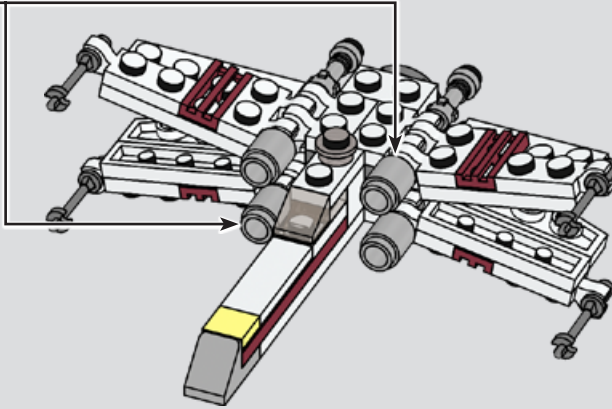

1x
4558168



1x
6345886



2x
4161326



1x
6245263



4x
4211412



1x
6178919



4x
6250678



4x
371001



2x
302301



2x
4160857



1x
6252039



1x
6372076



1x
6000606



1x
6275877



1x
366601



8x
6347287



2x
4160857



4x
4541506



1x
6093859



1x
6055313



1x
6051507



1x
6018774



4x
6361170



1x
6129995



1x
4539062



4x
4539481



4x
6310596