

9

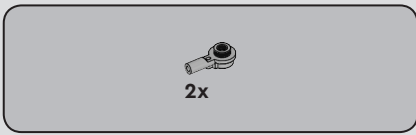

10

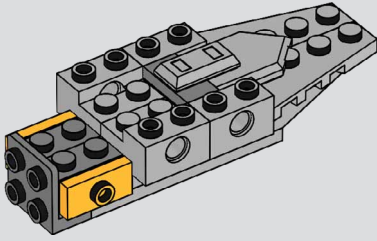
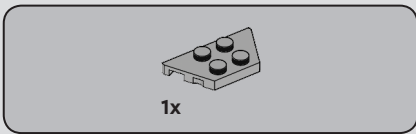
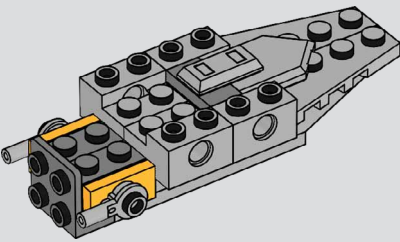

11

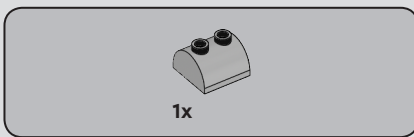
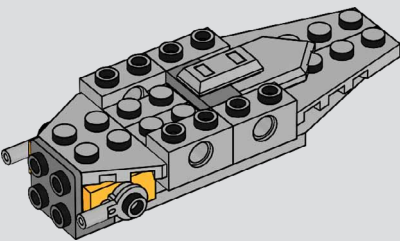

12

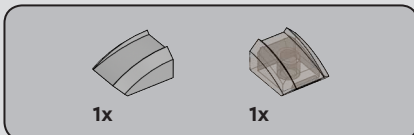
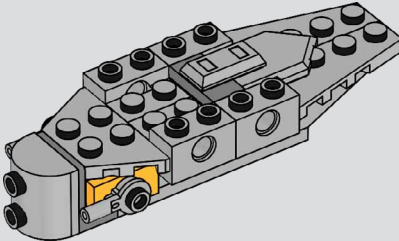

13

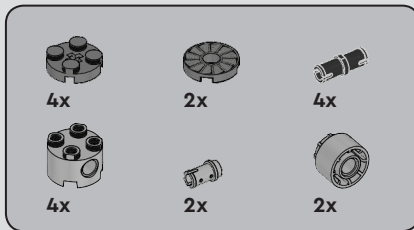
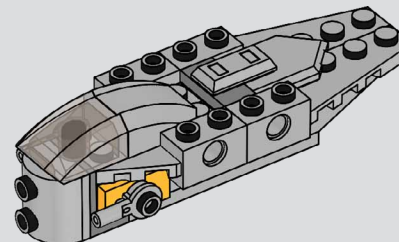

14

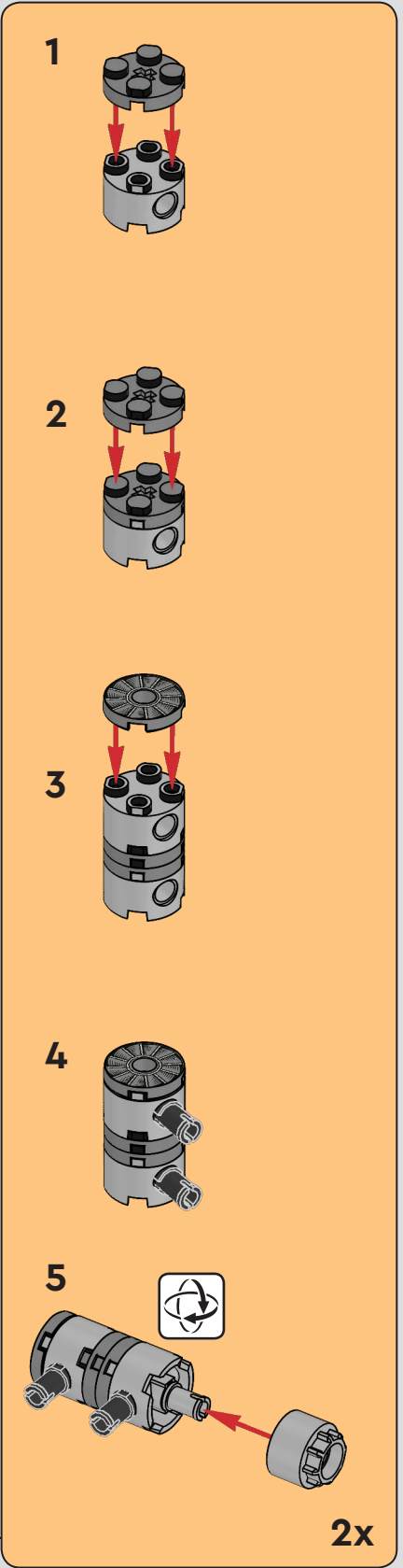
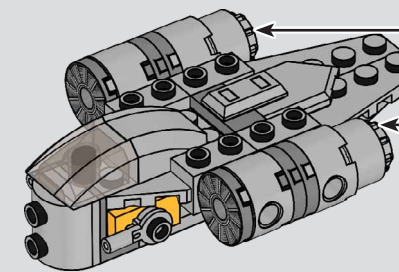

LEGO, the LEGO logo, the Brick and Knob configurations and the Minifigure are trademarks of the LEGO Group. © 2022 The LEGO Group. © &™ 2022 LUCASFILM LTD. All rights reserved. Manufactured by Blue Ocean Entertainment AG under licence from the LEGO Group.