

1

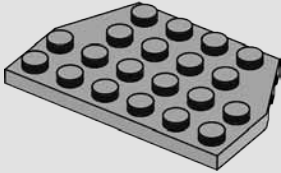

2

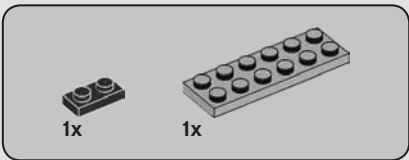
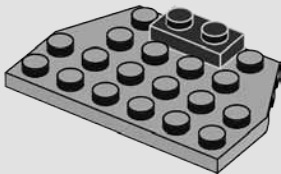

3

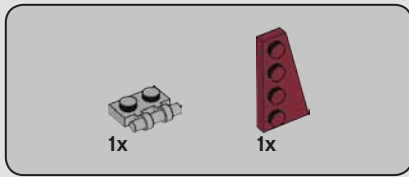
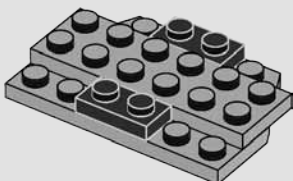

4

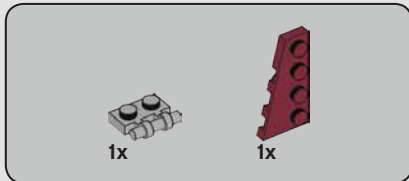
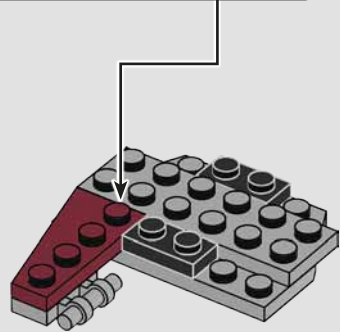
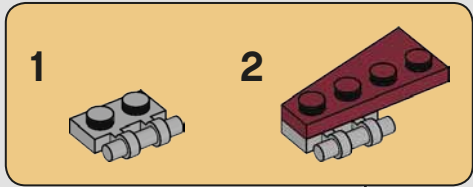

5

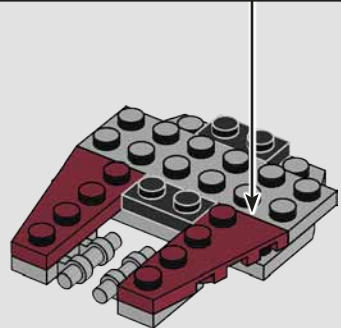
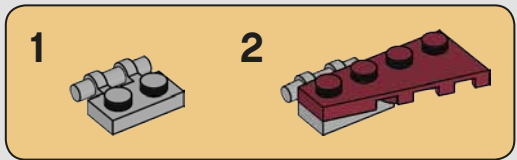

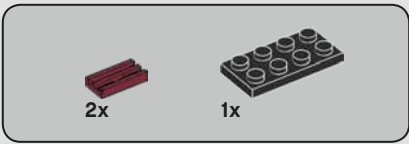

6

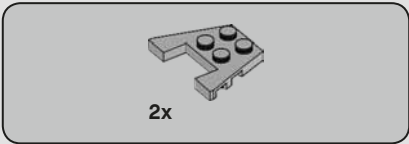
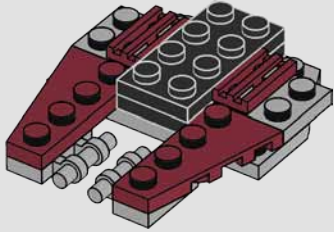

7

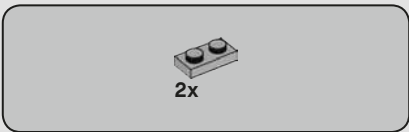
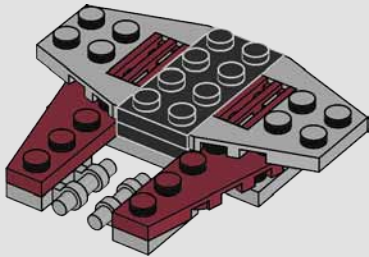

8

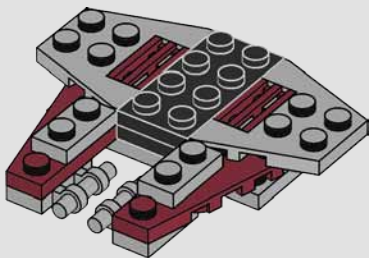

9

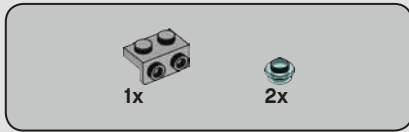
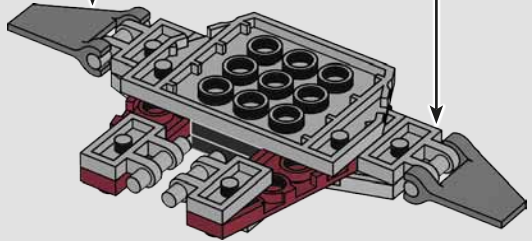
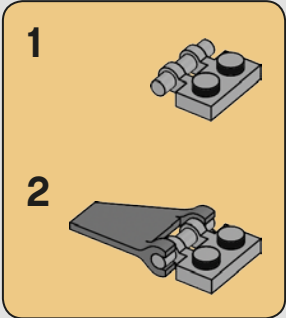
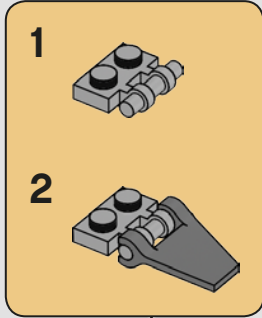

10

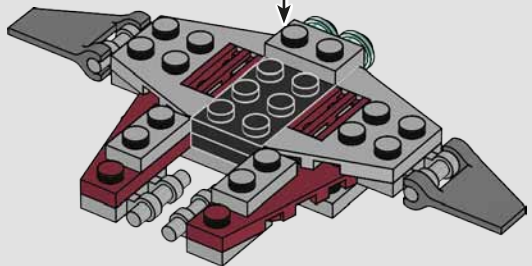
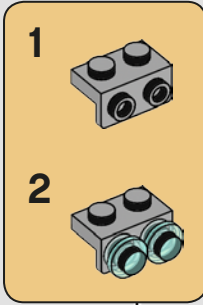



11

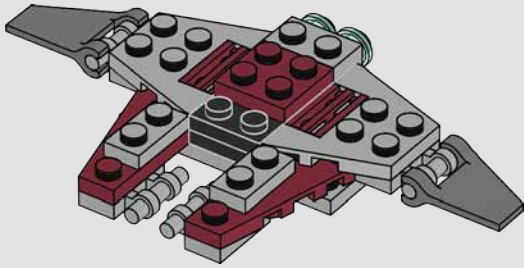

12

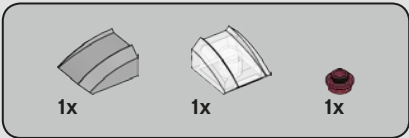
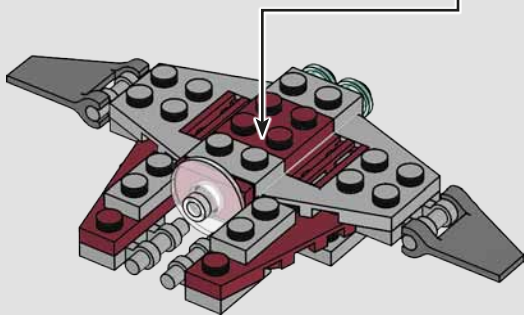
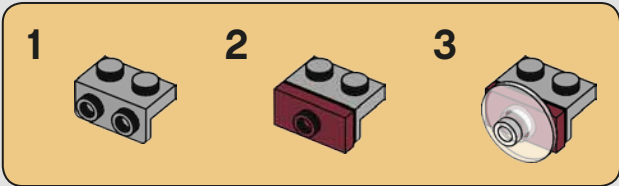

13

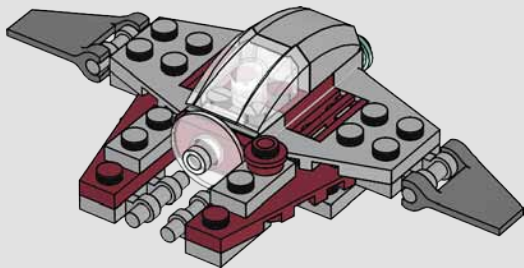

14

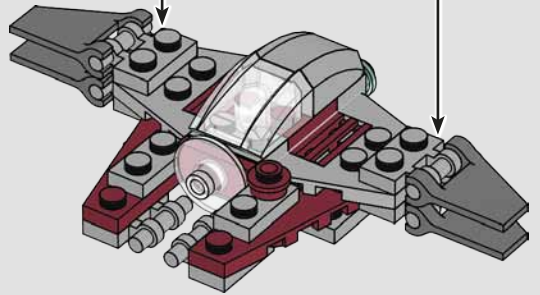
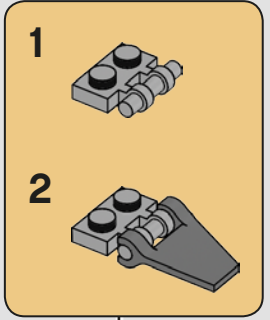
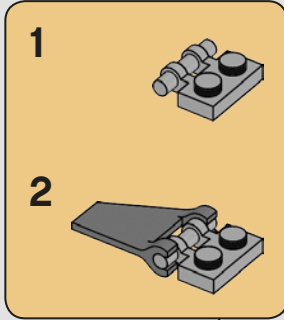

15

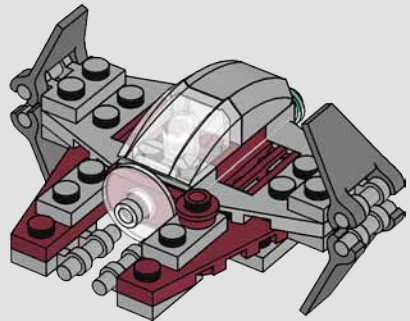

2x
302326

1x
302026

1x
6245306

1x
6166113

1x
4585479

1x
6008593

1x
6008595

2x
4541506

1x
6092597

1x
6168645

2x
4654582

6x
4211632

1x
4162889

2x
6170521

2x
4211398

1x
4211452

1x
4211725

4x
4215387

2x
6240225