

1

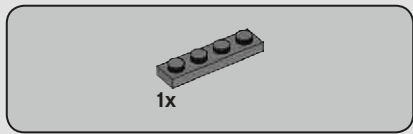

2

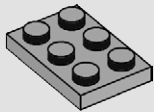
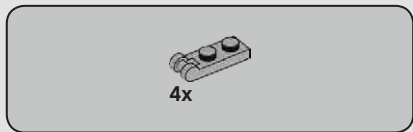
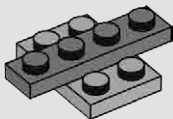

3

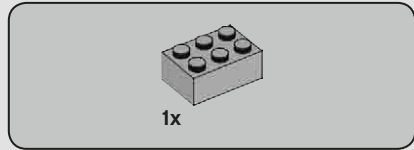
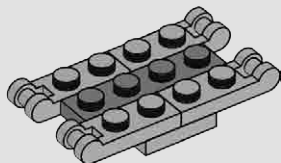

4

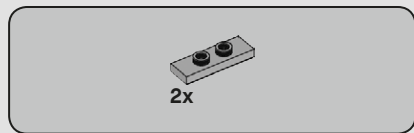
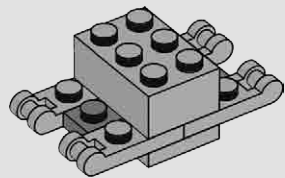

5

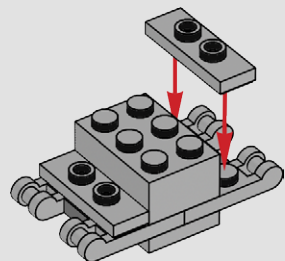

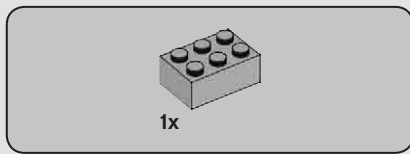

6

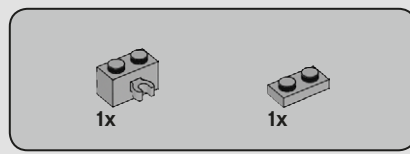
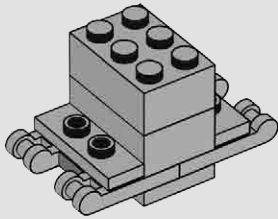

8

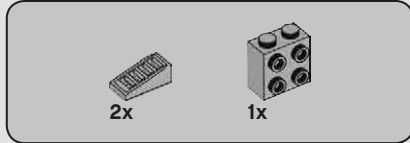
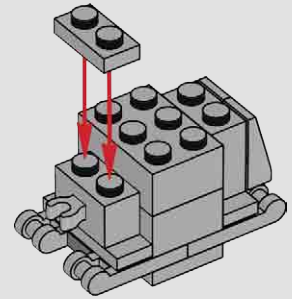

7

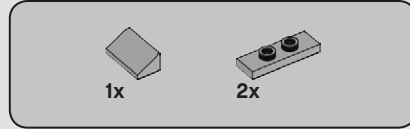
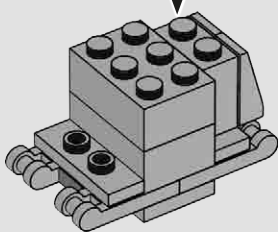
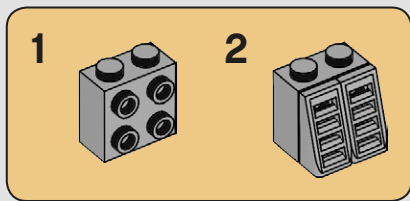

9

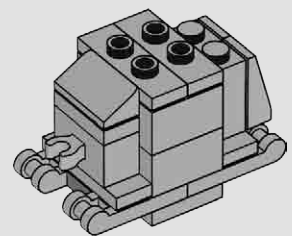

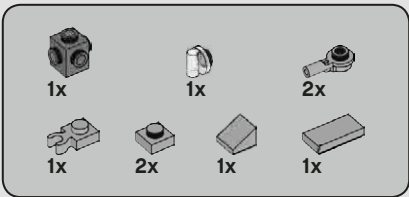

# 10

1



2



3

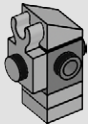

4

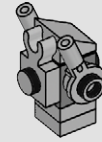

5

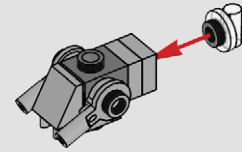

6

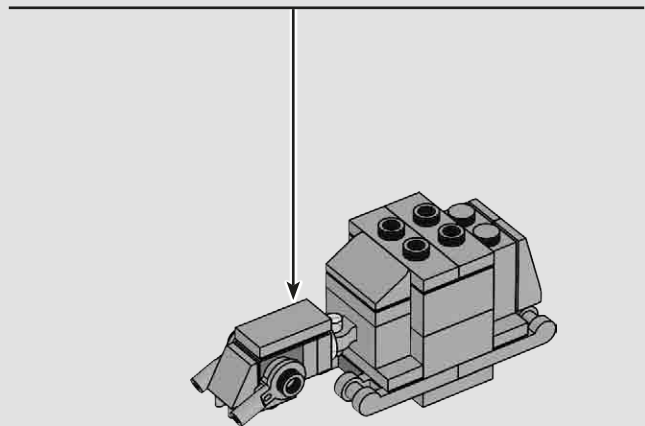
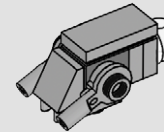

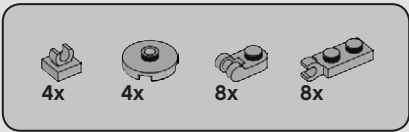
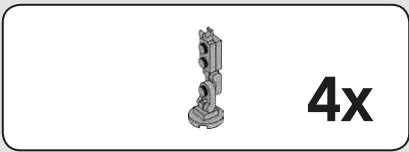

# 11

1



2



3

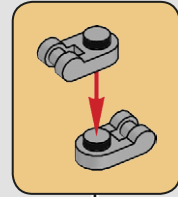

4

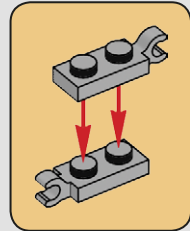
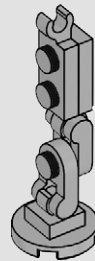

4x

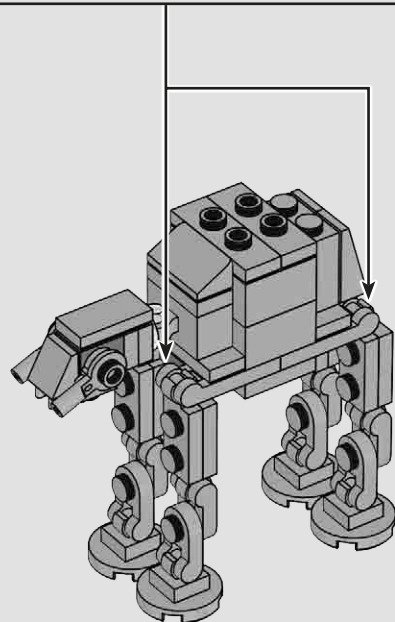



1x  
6321083



4x  
6308012



1x  
4521921



2x  
4211399



8x  
6225246



1x  
6296894



2x  
6227897



1x  
4568637



4x  
6183782



1x  
4211398



1x  
6123809



1x  
4211414



4x  
4515369



2x  
6092111



8x  
6319336



4x  
6211969



1x  
6320297



1x  
4211396



2x  
4211386



1x  
4210700



1x  
4211001