

1

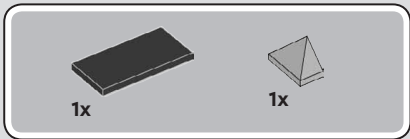

2

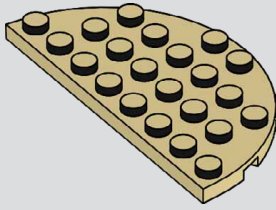
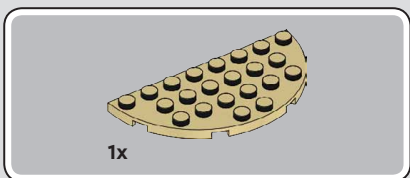
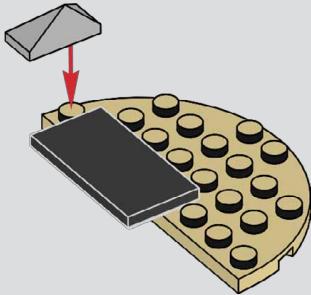

3

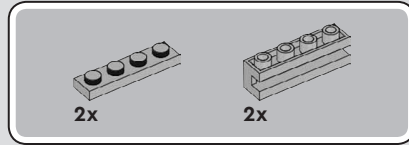
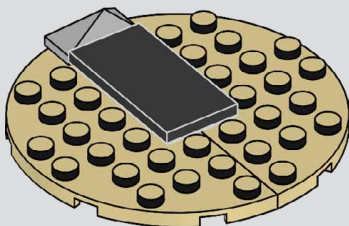

4

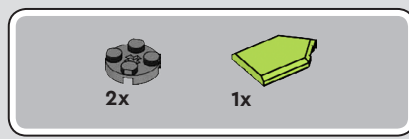
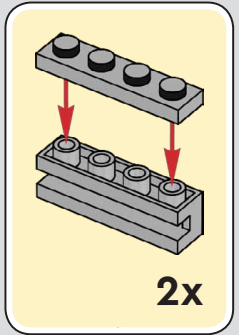
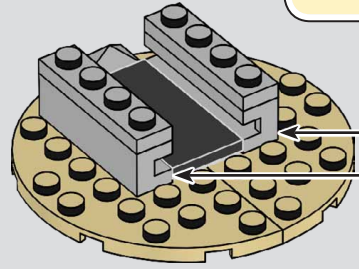

5

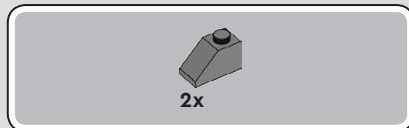
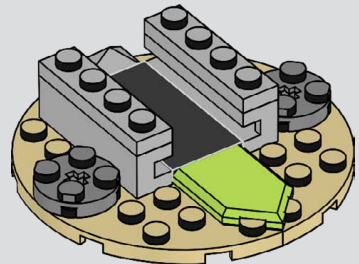

6

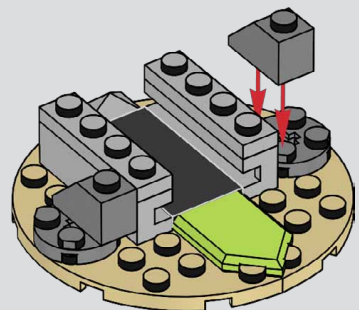

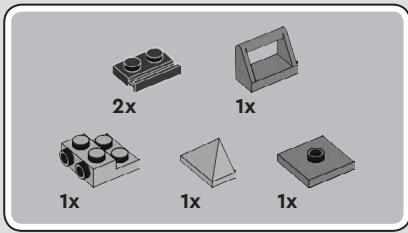

7

1

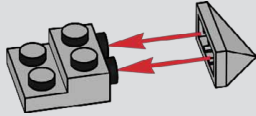

2

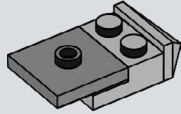

3

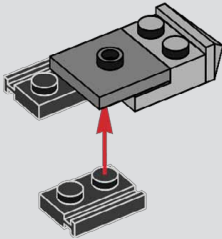

4

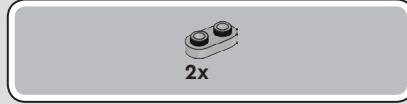
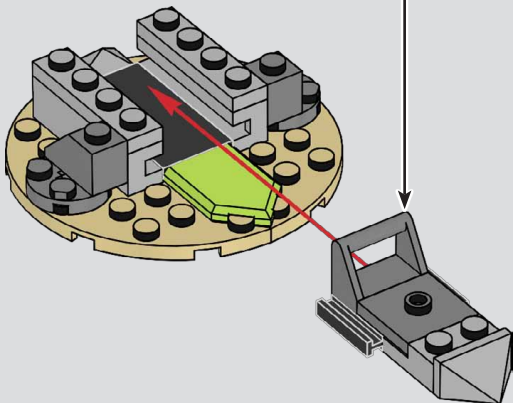
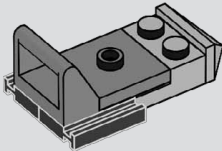

8

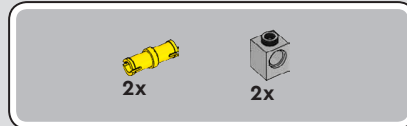
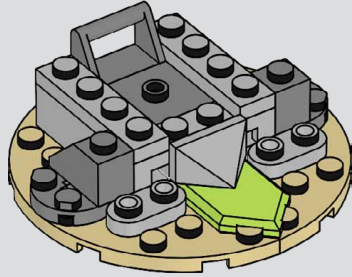

9

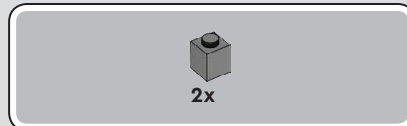
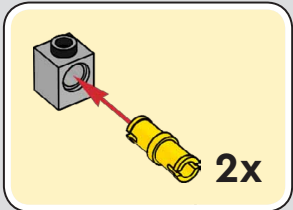
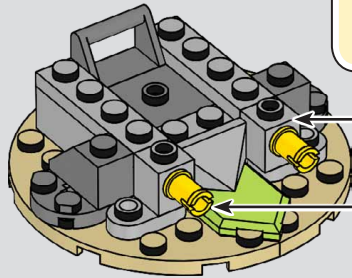

10

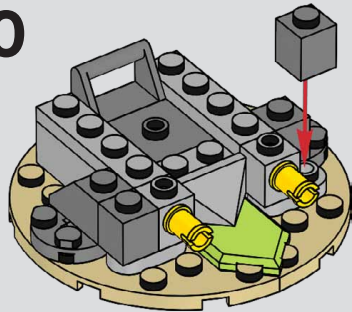

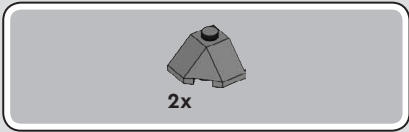

11

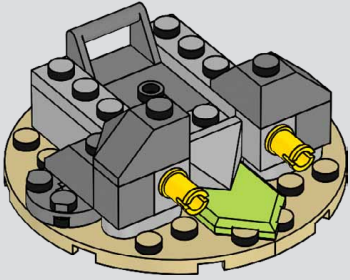

12

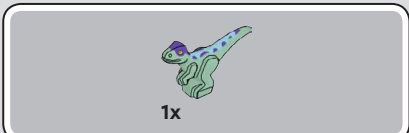
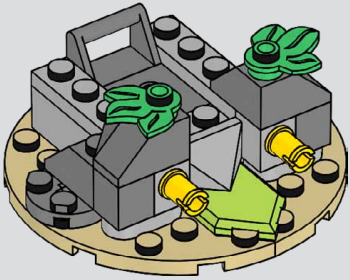

13

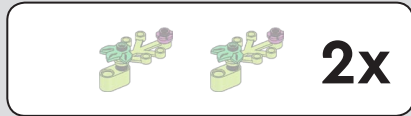
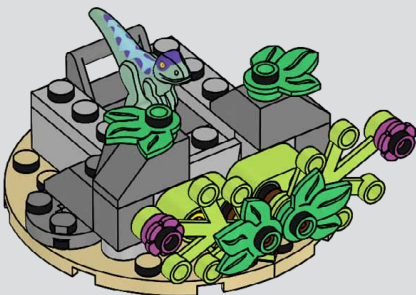

14

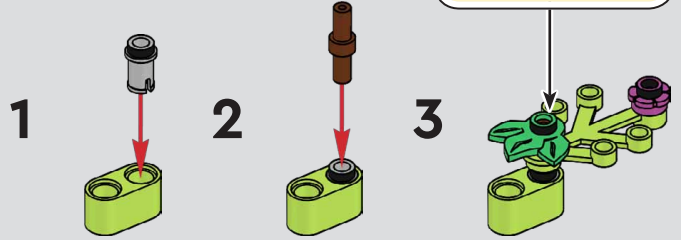
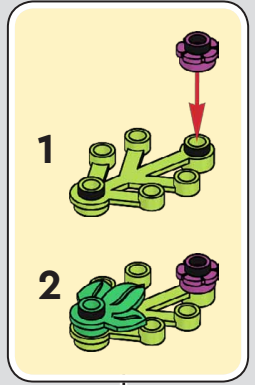

2x

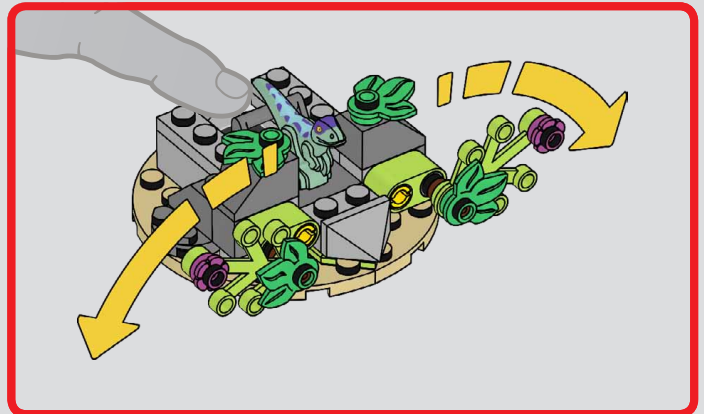
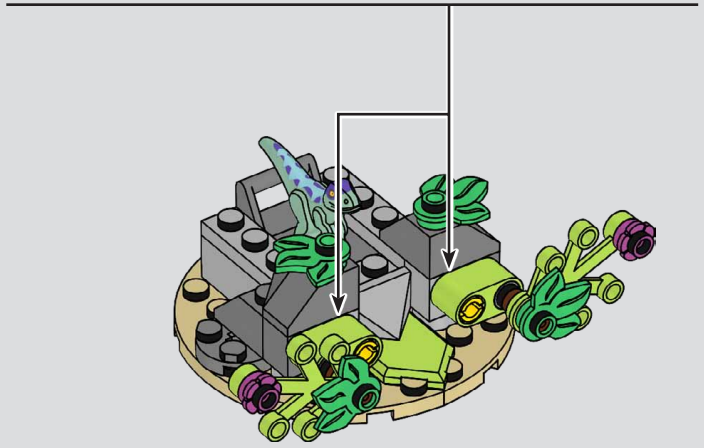



2x
6123812



2x
6451002



1x
6469440



2x
6149993



2x
6331822



2x
4211042



2x
4211613



2x
6248890



2x
6268818



1x
4560182



2x
6227909



2x
4211535



2x
4211483



1x
6253457



2x
4107761



1x
6126083



2x
6075075



2x
4211098



2x
6209682



4x
6229130



1x
4211039



2x
4211445



2x
4211135



1x
6469332