



1



2



3



4

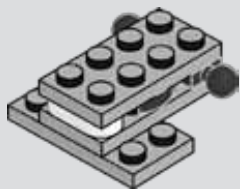

5

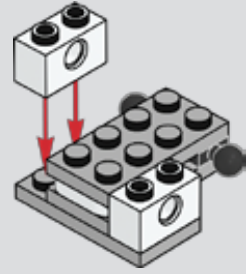

6

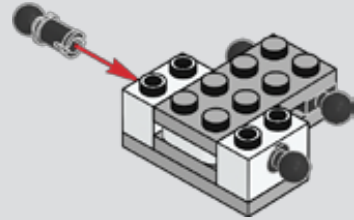

7

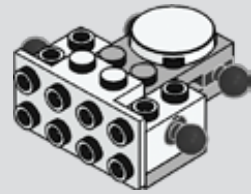

8

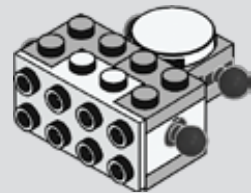

9

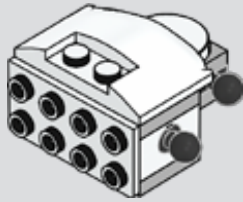

10

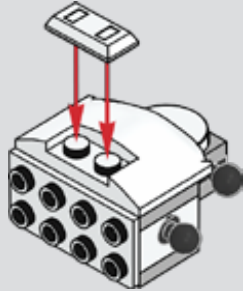

11

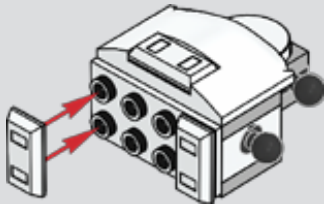

12

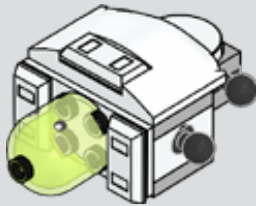

13

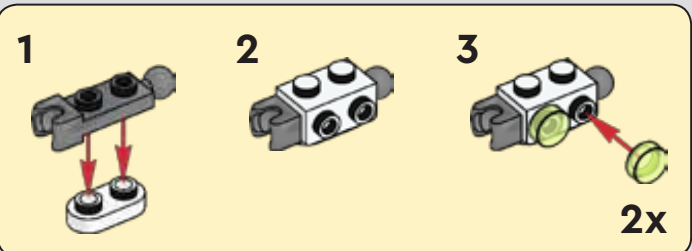
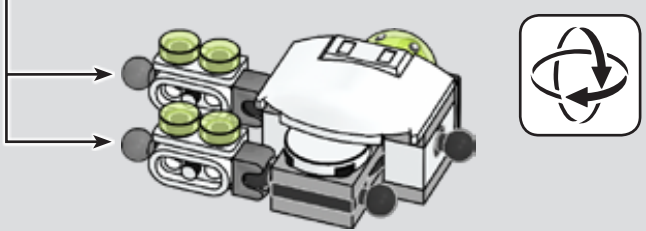
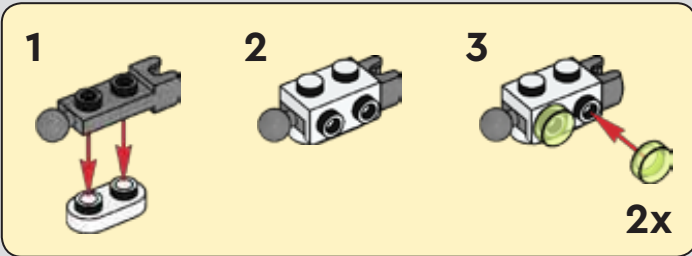

14



15

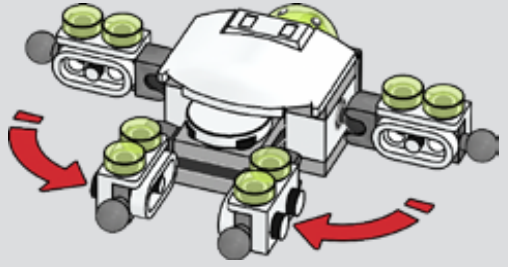

16

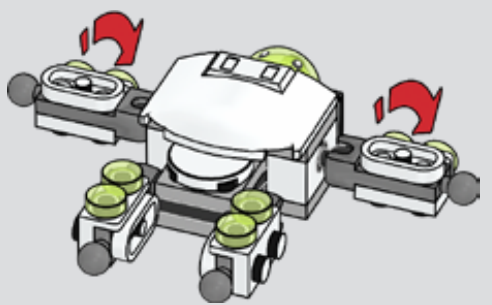

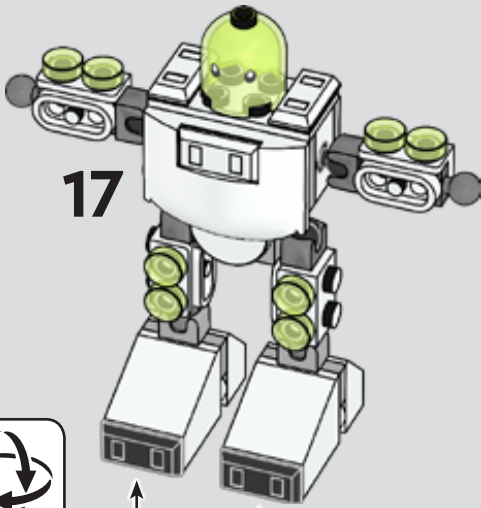

17

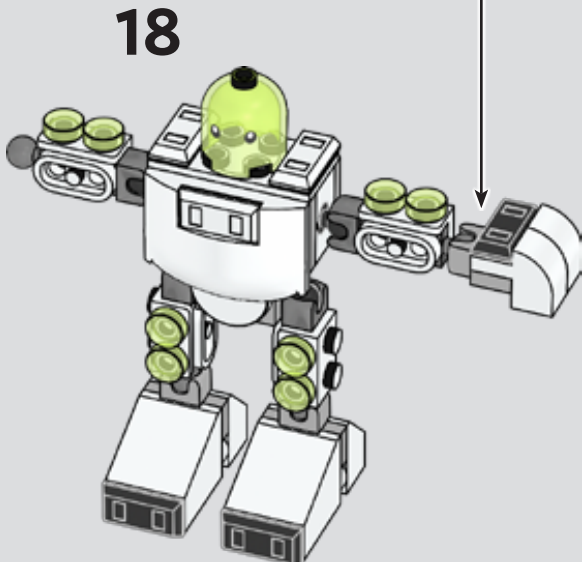
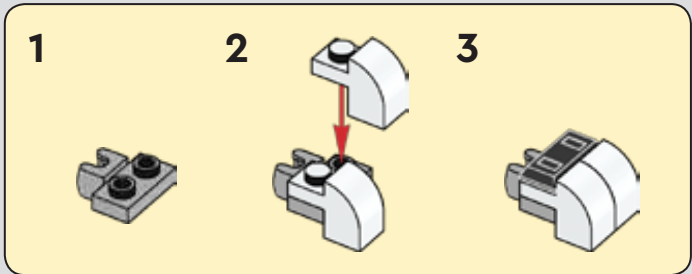
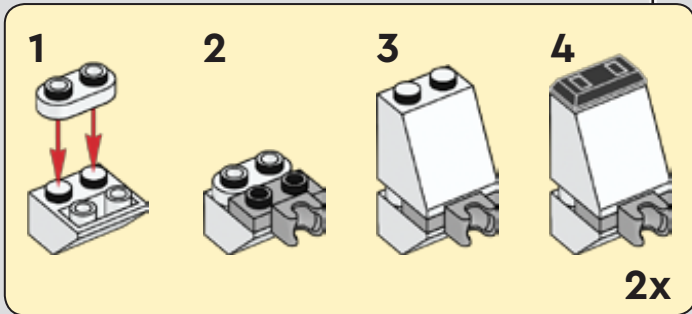
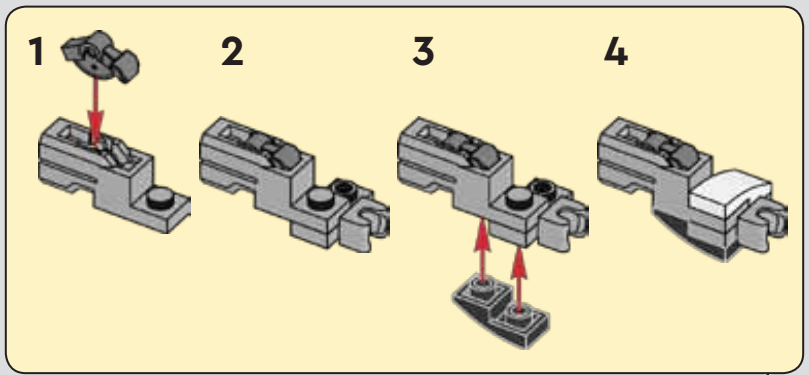

18

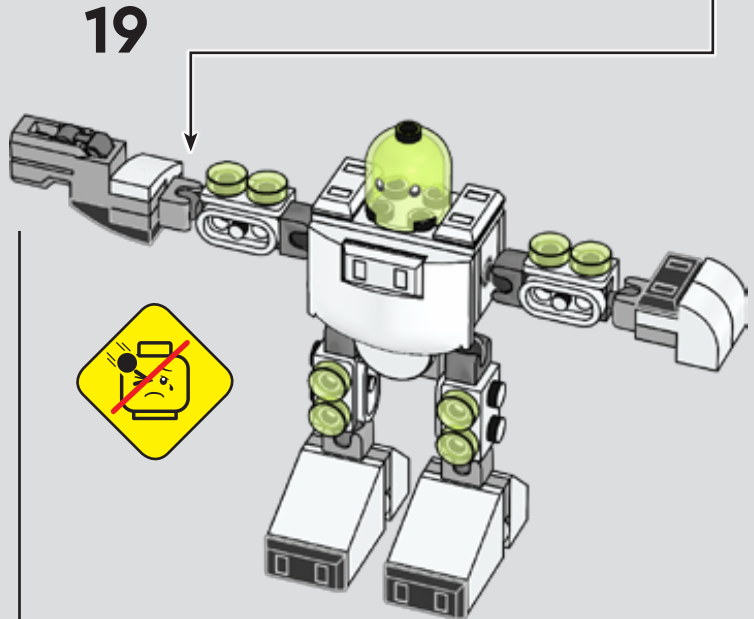

19

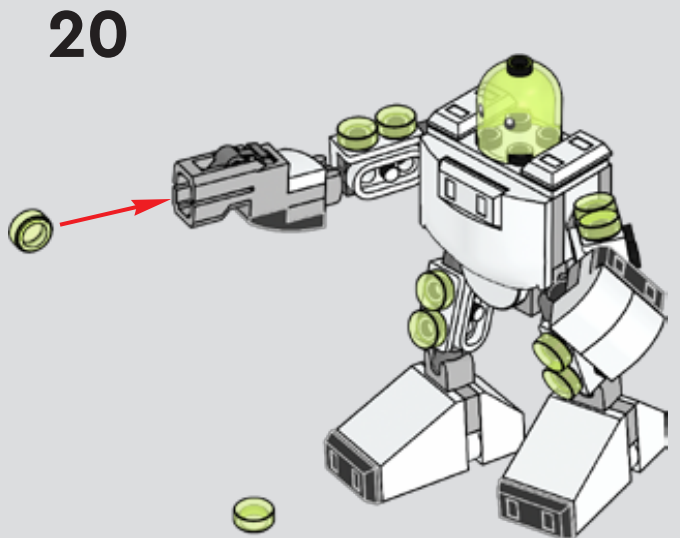

20

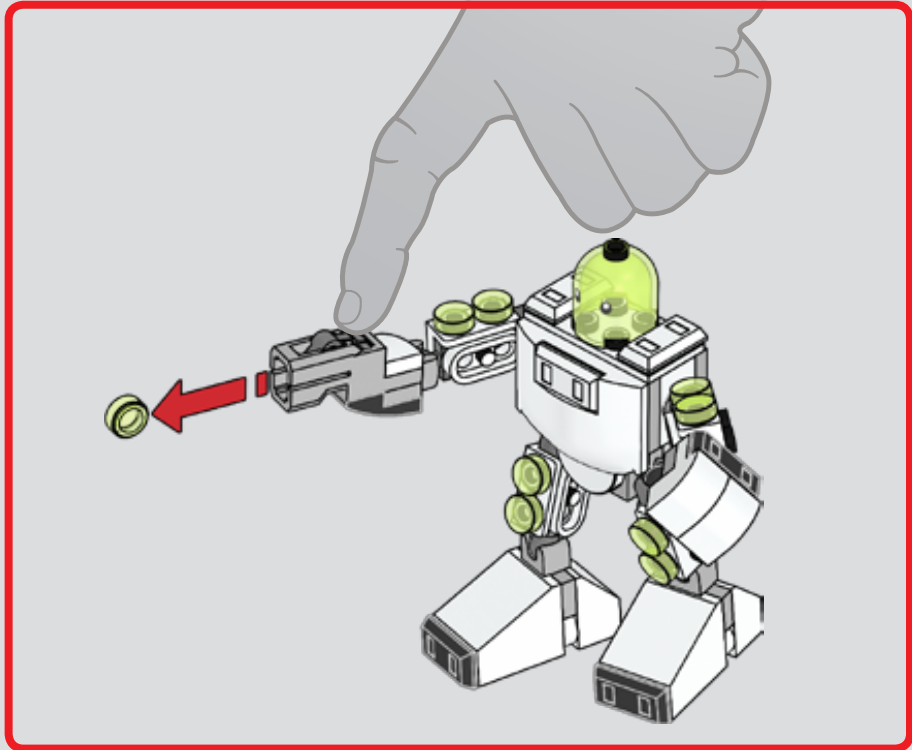

LEGO, the LEGO logo, the Brick and Knob configurations, the Minifigure and DREAMZzz are trademarks of the LEGO Group. ©2024 The LEGO Group.

Manufactured by Blue Ocean Entertainment AG, Seidenstraße 19, 70174 Stuttgart, Germany, under license from the LEGO Group.