

1

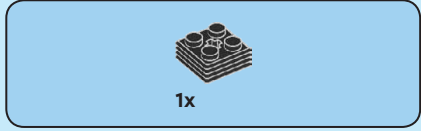

2

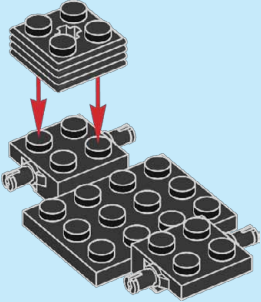
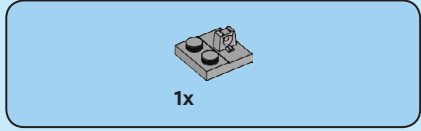
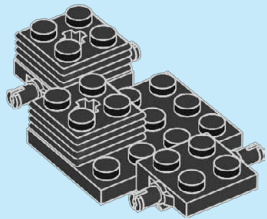

3

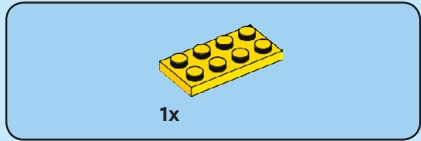
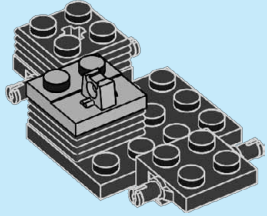

4

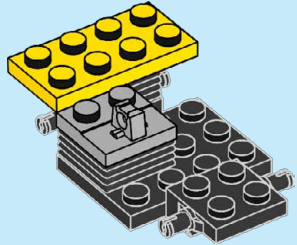

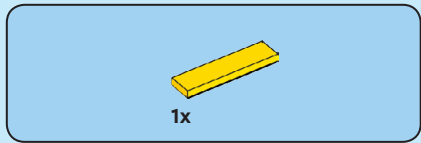

5

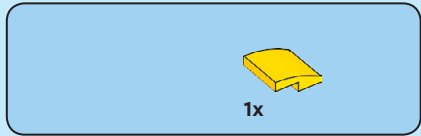

6

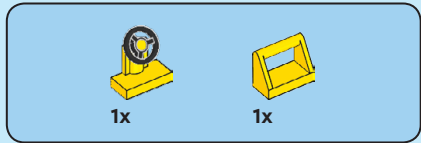
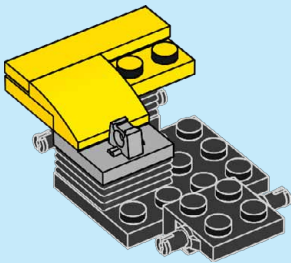

7

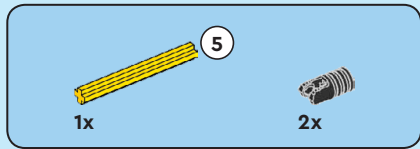
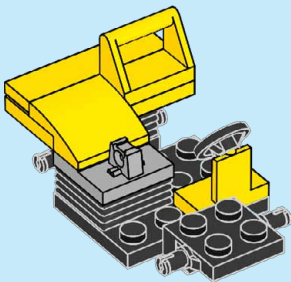

8

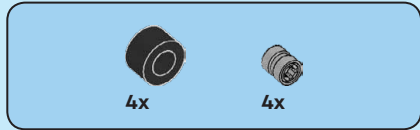
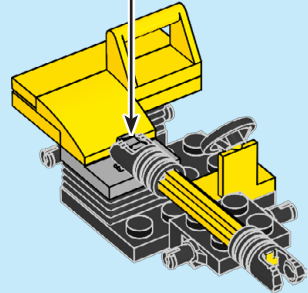
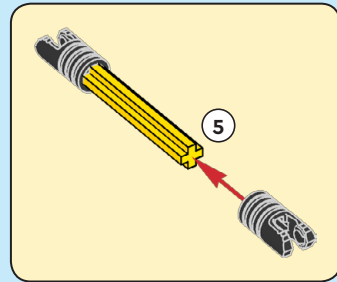

9

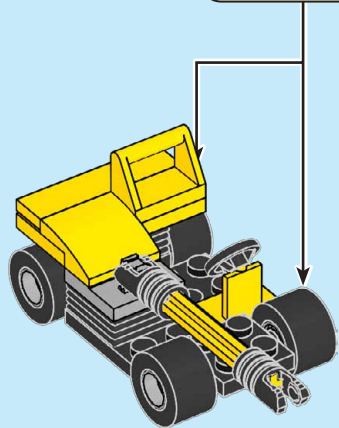
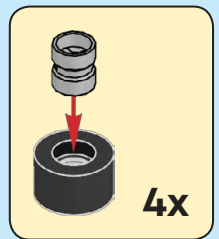

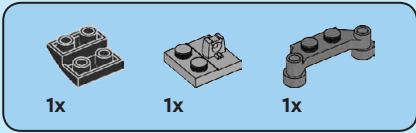

10

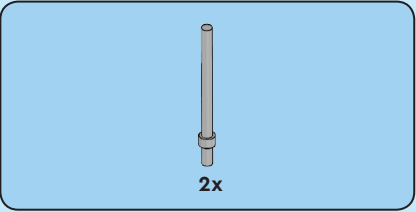
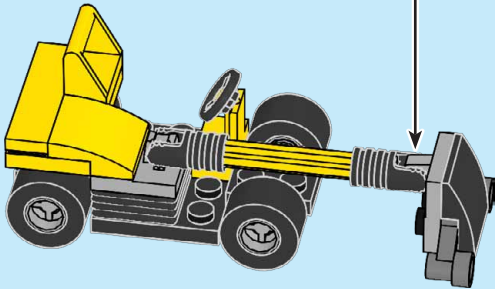
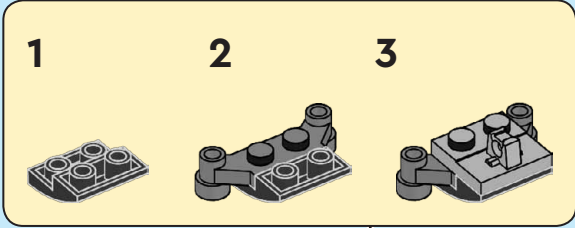

11

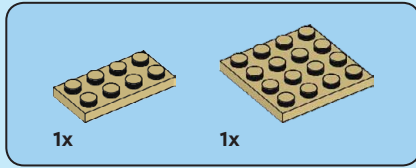
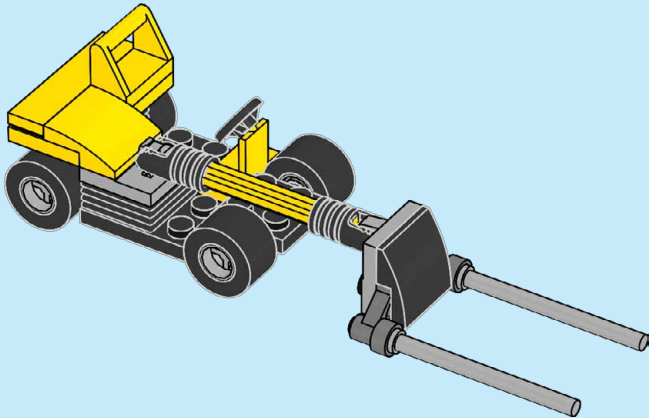

12

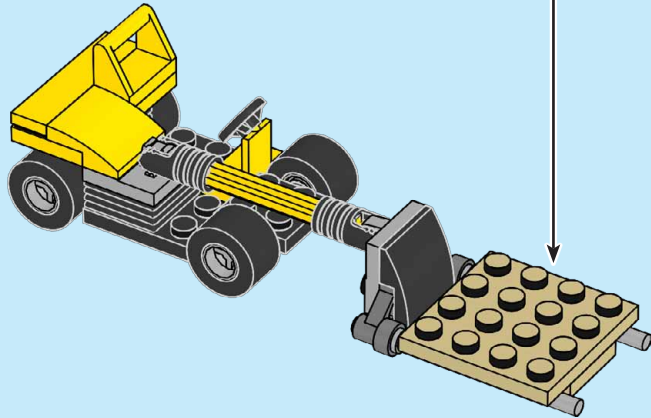
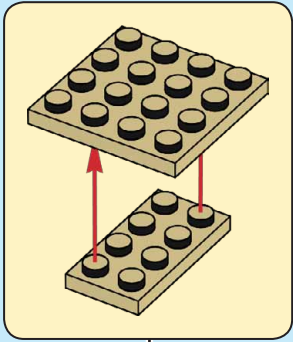

13

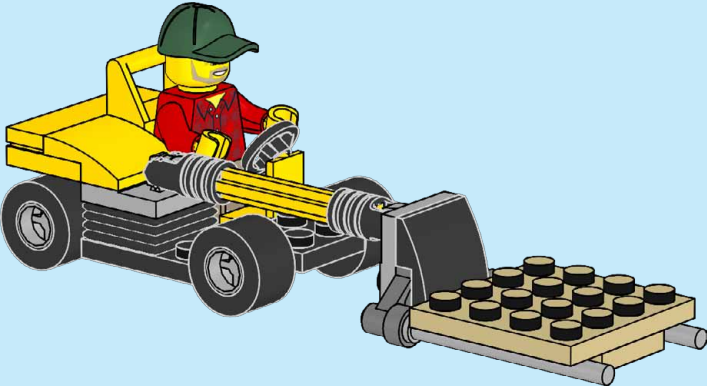



1x
9553



1x
6343796



2x
6265742



1x
6100249



1x
6217106



1x
6302647



1x
243224



4x
6011375



2x
6271535



1x
6079007



1x
6152679



4x
4508215



1x
243124



1x
4114309



2x
6325254



1x
302024



1x
4243824



1x
6211476



1x
6130008



2x
6170418

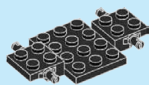

1x
6349350