

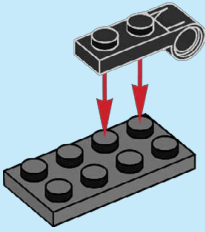

1

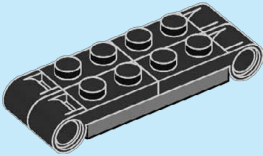

2



3

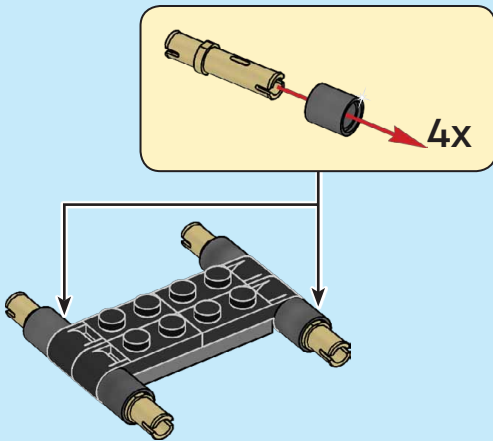

4

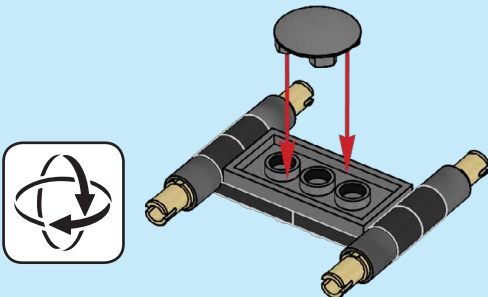

5

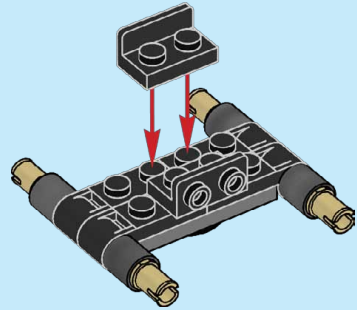

6

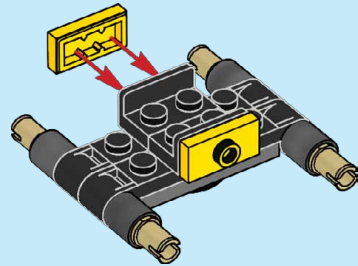

7

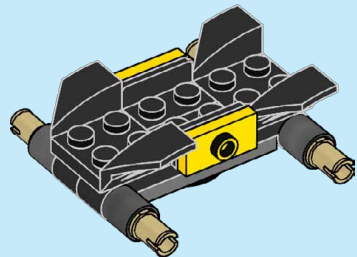

8

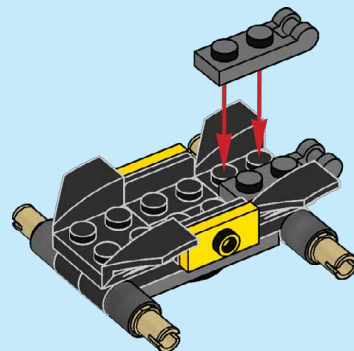

9

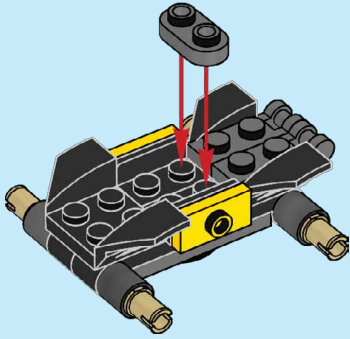

10

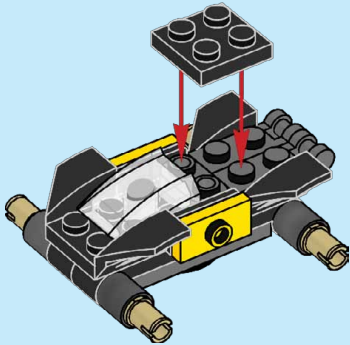

11

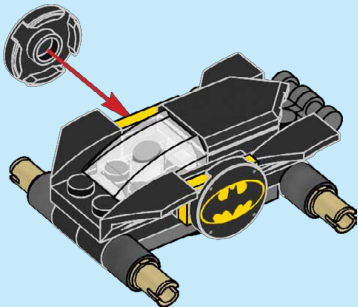

12

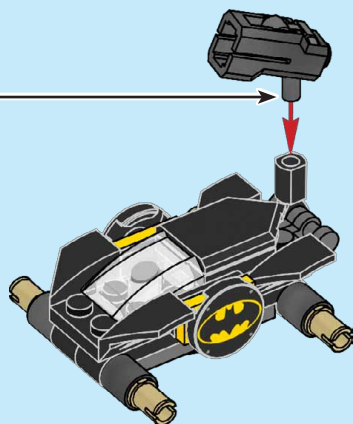
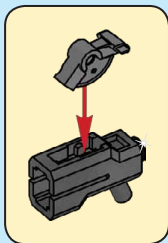

13

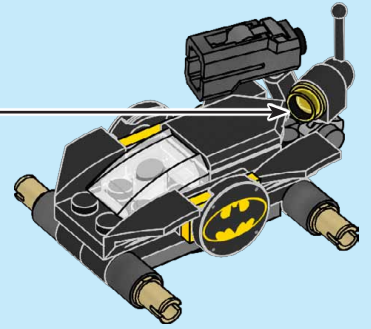
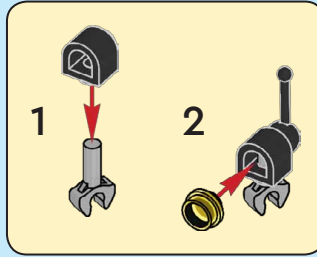

14

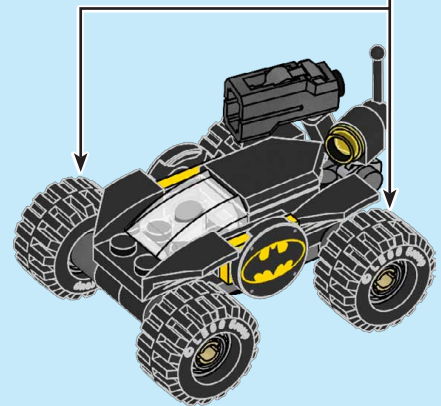
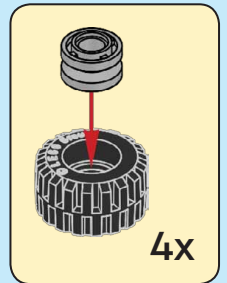

15

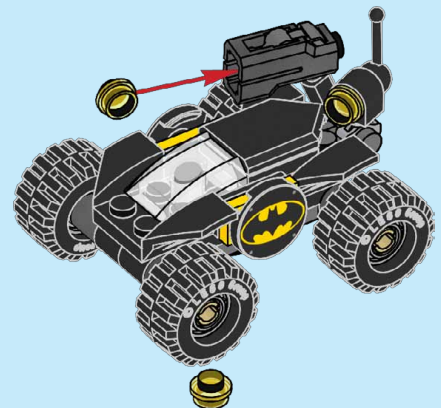

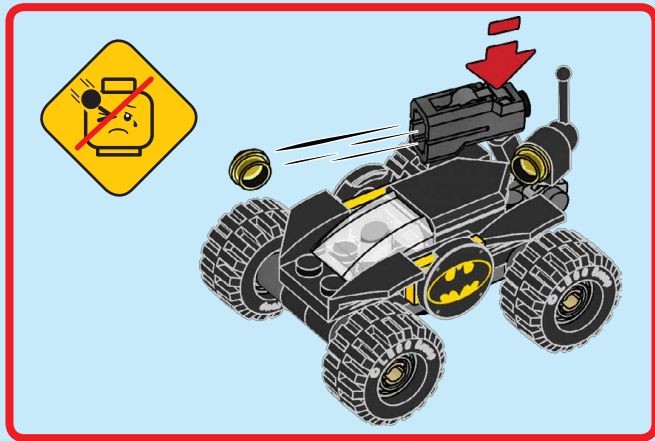

LEGO, the LEGO logo, the Minifigure and the Brick and Knob configurations are trademarks and/or copyrights of the LEGO Group. 2025 The LEGO Group. All rights reserved.



Copyright © 2025 DC. BATMAN and all related characters and elements © & ™ DC.
WB SHIELD: © & ™WBEL. (s25)



Manufactured by Blue Ocean Entertainment AG, Seidenstraße 19, 70174 Stuttgart, Germany, under license from the LEGO Group.