

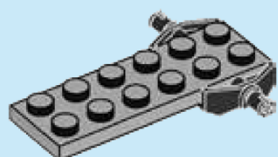

1

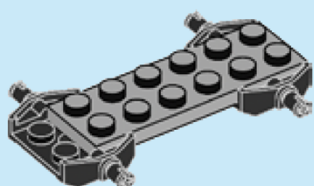

2



3

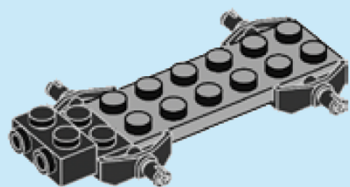

4

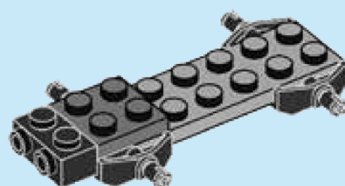

5

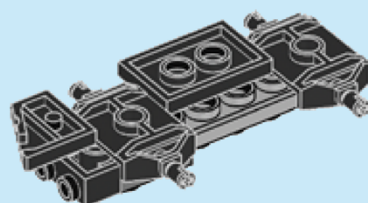

6

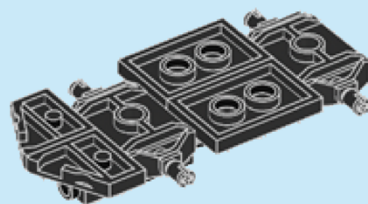

7

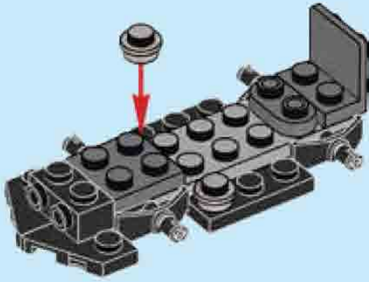

8

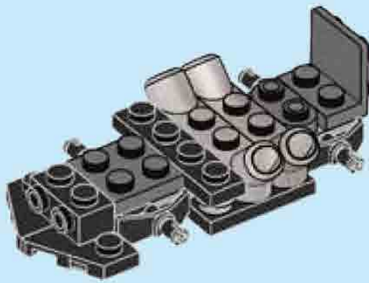

9

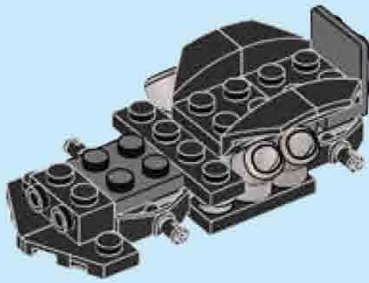

10

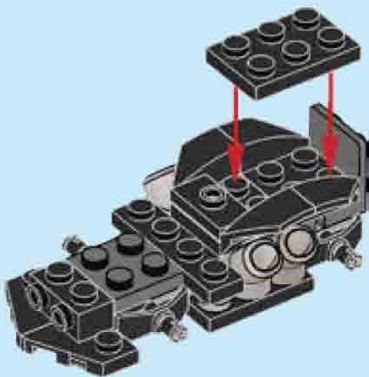

11

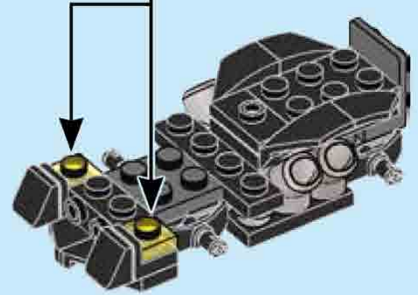
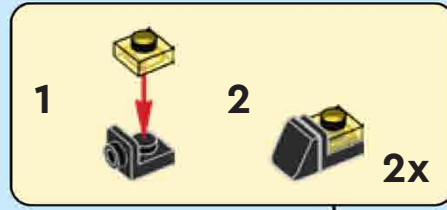

12

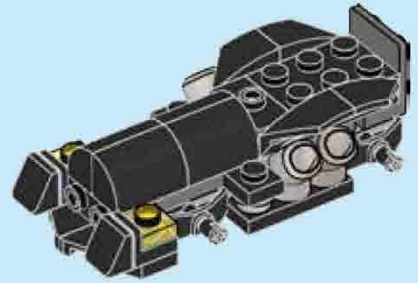

13

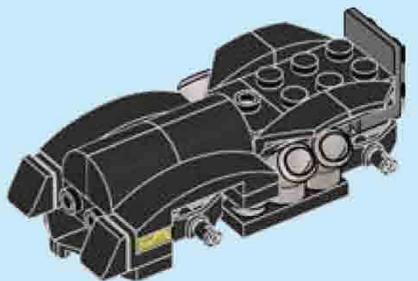

14

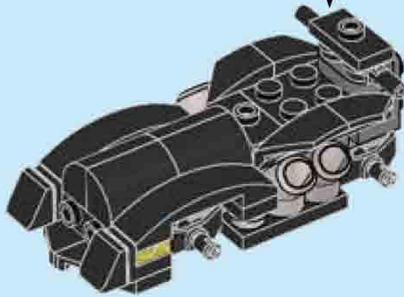
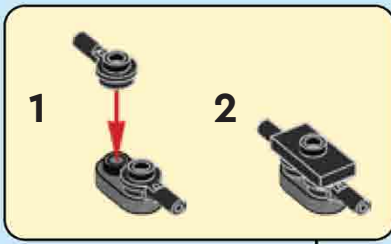

15

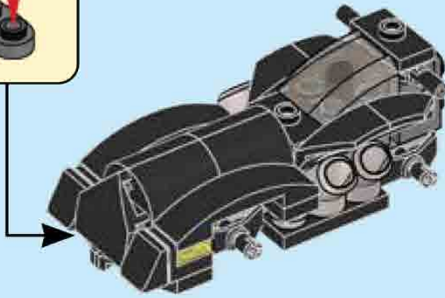

16



17

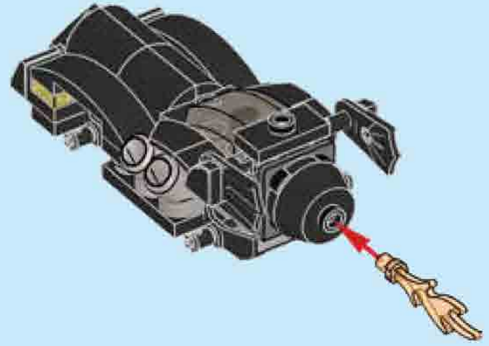

18

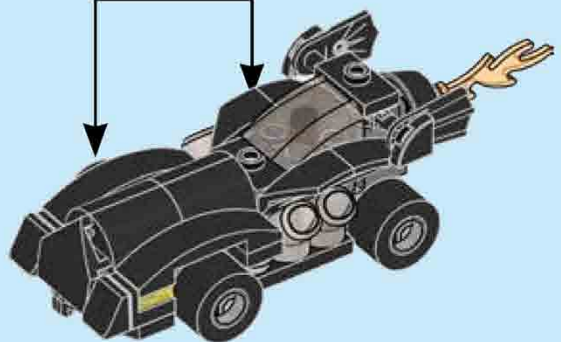
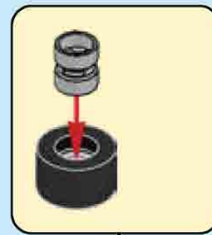

LEGO, the LEGO logo, the Minifigure and the Brick and Knob configurations are trademarks and/or copyrights of the LEGO Group. 2022 The LEGO Group. All rights reserved.



Copyright © 2022 DC Comics. BATMAN and all related characters and elements © & ™ DC Comics. WB SHIELD: © & ™ WBEI. (s22)



Manufactured by Blue Ocean Entertainment AG under licence from the LEGO Group.